

Virtual Acoustic Musical Instruments: Review of Models and Selected Research

Julius O. Smith III (jos@ccrma.stanford.edu)
Center for Computer Research in Music and Acoustics (CCRMA)
Department of Music, Stanford University
Stanford, California 94305

Oct. 19, 2005

Presentation Overheads
IEEE Workshop on Applications of Signal Processing
to Audio and Acoustics (WASPAA-05)
Oct. 16–19, 2005

<http://ccrma.stanford.edu/~jos/Mohonk05/>

Outline

In *historical order*, with selected updates:

- Voice Synthesis
- Karplus-Strong Algorithm
- Waveguide Synthesis
- Commuted Synthesis
- Virtual Analog

Voice Modeling

Linear Prediction (LP) Vocal Tract Model

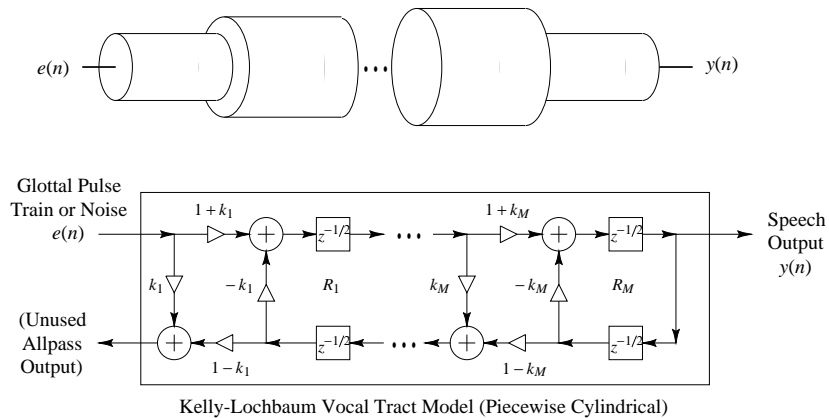

John L. Kelly and Carol Lochbaum (1962)

Sound Example

“Bicycle Built for Two”: (WAV) (MP3)

- Vocal part by Kelly and Lochbaum (1961)
- Musical accompaniment by Max Mathews
- Computed on an IBM 704
- Based on Russian speech-vowel data from Gunnar Fant's recent book
- Probably the first digital physical-modeling synthesis sound example by any method
- Inspired Arthur C. Clarke to adapt it for “2001: A Space Odyssey” — the computer's “first song”

“Shiela” Sound Examples by Perry Cook (1990)

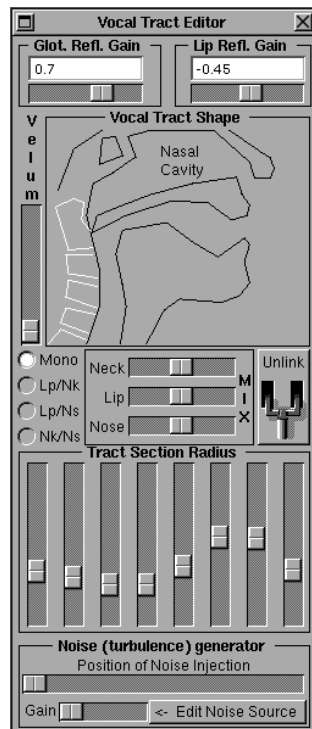

- Diphones: (WAV) (MP3)
- Nasals: (WAV) (MP3)
- Scales: (WAV) (MP3)
- “Shiela”: (WAV) (MP3)

5

Recent Voice Modeling Efforts

Linear Prediction (LP) Vocal Tract Model

- Can be interpreted as a modified Kelly-Lochbaum model
- In linear prediction, the glottal excitation must be an
 - *impulse*, or
 - *white noise*

This prevents LP from finding a physical vocal-tract model

- A *more realistic glottal waveform $e(n)$* is needed before the vocal tract filter can have the “right shape”
- How to augment LPC in this direction without going to a full-blown *articulatory synthesis model*?
 - Jointly estimate *glottal waveform $e(n)$* so vocal-tract filter can have the “right shape”

6

Klatt Derivative Glottal Wave

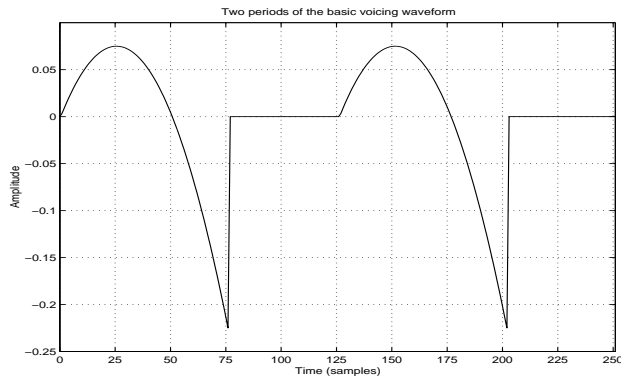

- Good for estimation:
 - Truncated *parabola* each period
 - Coefficients easily fit to *phase-aligned* inverse-filter output

Sequential Unconstrained Minimization

(Hui Ling Lu, 2002)

Klatt glottal (parabola) parameters are estimated *jointly* with vocal tract filter coefficients

- Formulation resembles that of the *equation error method for system identification*
- For *phase alignment*, we estimate
 - pitch (time varying)
 - glottal closure instant each period
- Optimization is *convex* in all but the phase-alignment dimension

Liljencrantz-Fant Derivative Glottal Wave Model

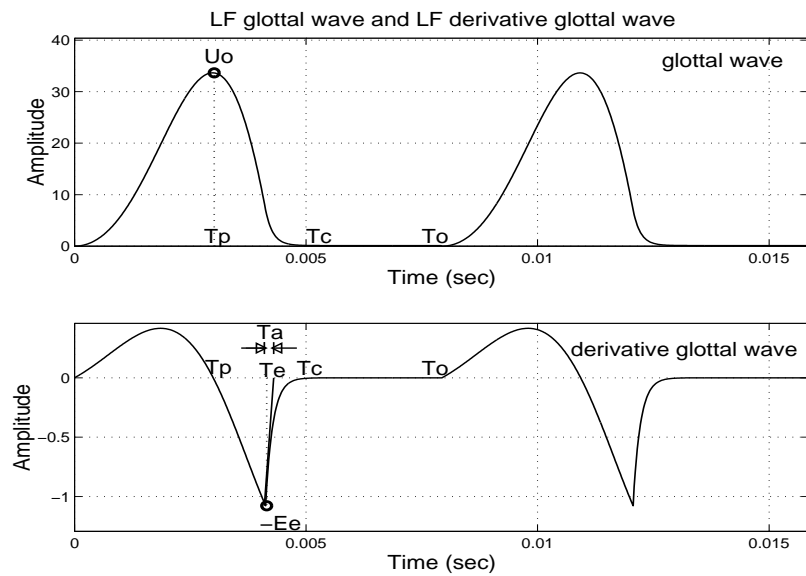

- Better for *intuitively parametrized expressive synthesis*
- LF model parameters are fit to *inverse filter* output
- Use of Klatt model in forming filter estimate yields a “more physical” filter than LP

Parametrized Phonation Types

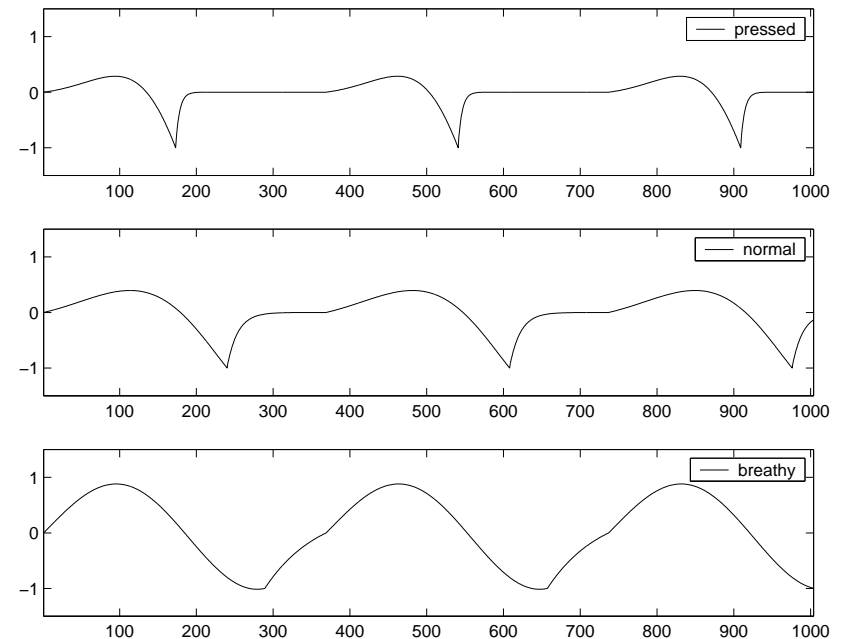

Sound Examples by Hui Ling Lu

- Original: (WAV) (MP3)
- Synthesized:
 - Pressed Phonation: (WAV) (MP3)
 - Normal Phonation: (WAV) (MP3)
 - Breathy Phonation: (WAV) (MP3)
- Original: (WAV) (MP3)
- Synthesis 1: (WAV) (MP3)
- Synthesis 2: (WAV) (MP3)

where

- Synthesis 1 = Estimated Vocal Tract driven by estimated KLGLOT88 Derivative Glottal Wave (Pressed)
- Synthesis 2 = Estimated Vocal Tract driven by the fitted LF Derivative Glottal Wave (Pressed)

Google search: *singing synthesizer vocal texture control*
(Hui Ling Lu's thesis page at CCRMA)

Voice Model Estimation

(Pamornpol Jinachitra)

(to be presented later this morning)

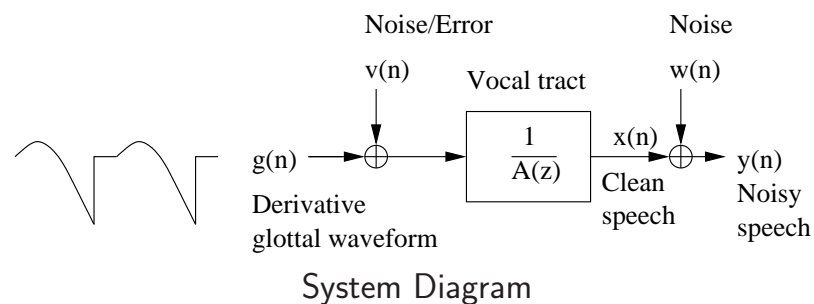

- Parametric source-filter model of voice + noise
- State-space framework with derivative glottal waveform as input and A model for dynamics
- Jointly estimate AR parameters and glottal source parameters using EM algorithm with Kalman smoothing
- Reconstruct a clean voice using Kelly-Lochbaum and estimated parameters

Karplus-Strong Algorithm

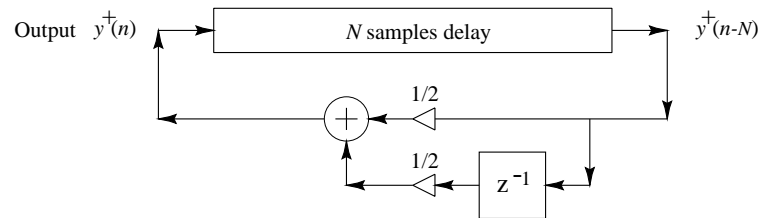

- Discovered (1978) as a self-modifying wavetable synthesis algorithm
- “Vintage” 8-bit sound examples:
 - Original Plucked String: (AIFF) (MP3)
 - Drum: (AIFF) (MP3)
 - Stretched Drum: (AIFF) (MP3)
- STK Plucked String: (WAV) (MP3)
 - Plucked String 1: (WAV) (MP3)
 - Plucked String 2: (WAV) (MP3)
 - Plucked String 3: (WAV) (MP3)
 - Plucked String 4: (WAV) (MP3)

Interpretations of the Karplus-Strong Algorithm

The Karplus-Strong structure can be *interpreted* as a

- *pitch prediction filter* from the Codebook-Excited Linear Prediction (CELP) standard (*periodic LPC synthesis*)
- *feedback comb filter with lowpassed feedback* used earlier by James A. Moorer for recursively modeling *wall-to-wall echoes* (“About This Reverberation Business”)
- simplified digital waveguide model

Digital Waveguide Models

A lossless digital waveguide \triangleq bidirectional delay line at some wave impedance R :

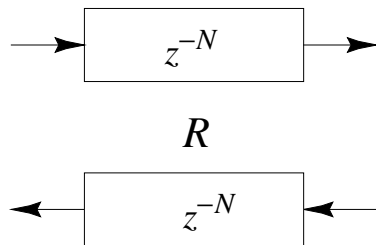

Useful for efficient models of

- strings
- bores
- plane waves
- conical waves

Signal Scattering

Signal scattering is caused by a change in wave impedance R :

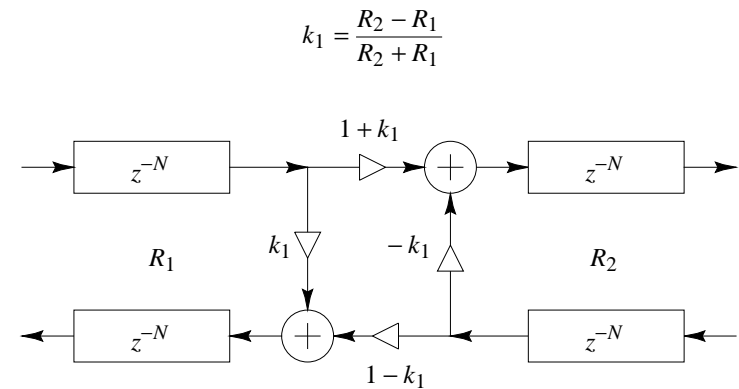

If the wave impedance changes *every sample*, the Kelly-Lochbaum vocal-tract model results.

Moving Termination: Ideal String

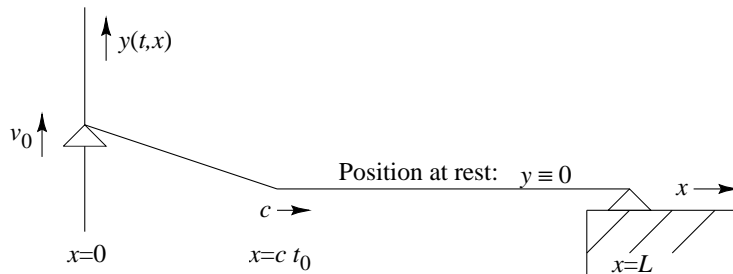

Moving rigid termination for an ideal string.

- Left endpoint moved at velocity v_0
- External force $f_0 = Rv_0$
- $R = \sqrt{K\epsilon}$ is the *wave impedance* (for transverse waves)
- Relevant to *bowed strings* (when bow pulls string)
- String moves with speed v_0 or 0 only
- String is always one or two straight segments
- “Helmholtz corner” (slope discontinuity) shuttles back and forth at speed $c = \sqrt{K/\epsilon}$

Digital Waveguide “Equivalent Circuits”

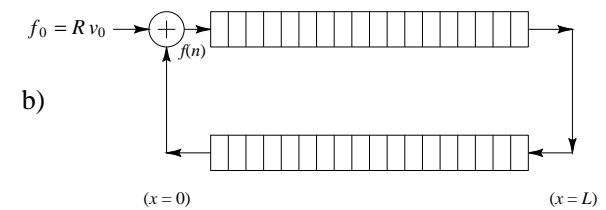
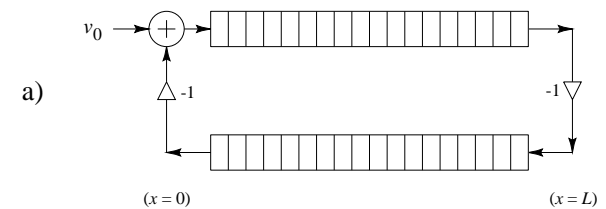

- a) Velocity waves.
- b) Force waves.

Animation:

<http://ccrma.stanford.edu/~jos/swgt/movet.html>

Ideal Plucked String (Displacement Waves)

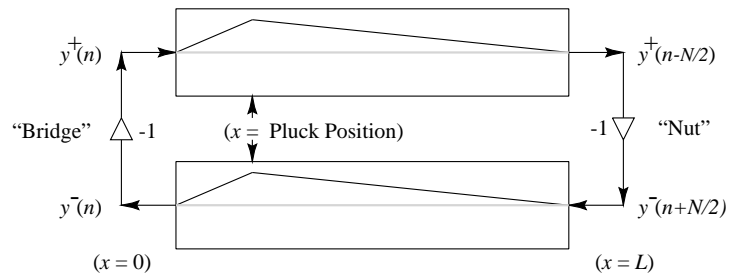

- Load each delay line with *half* of initial string displacement
- Sum of upper and lower delay lines = string displacement

Ideal Struck String (Velocity Waves)

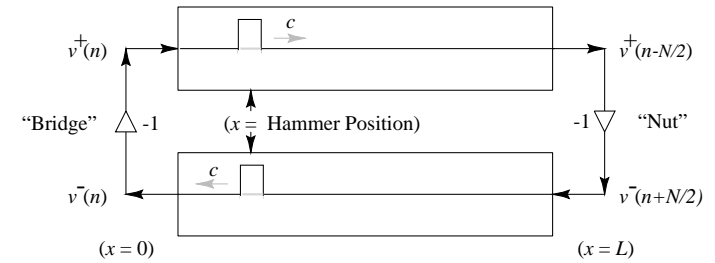

Hammer strike = *momentum transfer* = velocity step:

$$m_h v_h(0-) = (m_h + m_s) v_s(0+)$$

Digital Waveguide Interpretation of the Karplus-Strong Algorithm

Begin with an ideal *damped* string model:

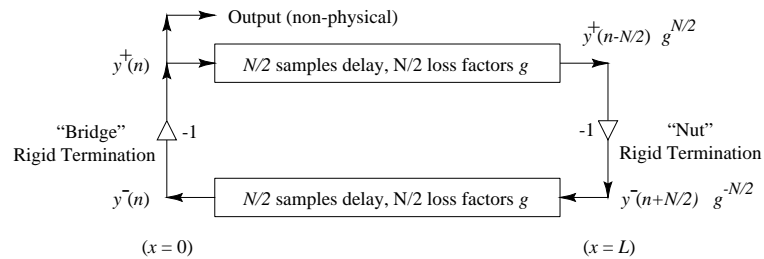

- Rigidly terminated string with distributed “resistive” losses (force \propto velocity)
- Sampled wave-equation solution yields N loss factors g embedded between the delay-line elements:

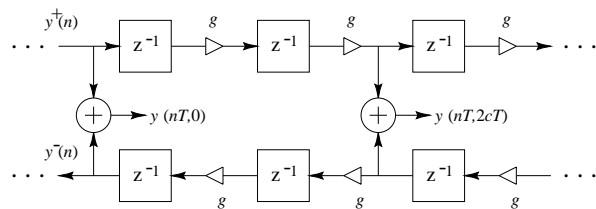

- Note that loss factors g commute with delay elements

Equivalent System: Gain Elements Commuted

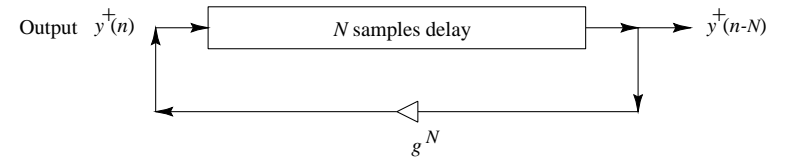

All N loss factors g have been “pushed” through delay elements and combined at a *single* point.

Computational Savings

- $f_s = 50\text{kHz}$, $f_1 = 100\text{Hz} \Rightarrow \text{delay} = 500$
- Multiplies reduced by two orders of magnitude
- Input-output transfer function unchanged
- Round-off errors reduced

Frequency-Dependent Damping

- Loss factors g should really be digital filters
- Gains in nature typically decrease with frequency
- Loop gain may not exceed 1 (for stability)
- Such filters *also commute* with delay elements (LTI)
- Typically only *one* gain filter used per loop

Simplest Frequency-Dependent Loop Filter

$$\hat{G}(z) = b_0 + b_1 z^{-1}$$

- Uniform delay $\Rightarrow b_0 = b_1$ (\Rightarrow delay = 1/2 sample)
- Zero damping at dc $\Rightarrow b_0 + b_1 = 1$
 $\Rightarrow b_0 = b_1 = 1/2$
 \Rightarrow

$$\hat{G}(e^{j\omega T}) = \cos(\omega T/2), \quad |\omega| \leq \pi f_s$$

- This is precisely the Karplus-Strong loop filter!

Karplus-Strong Algorithm

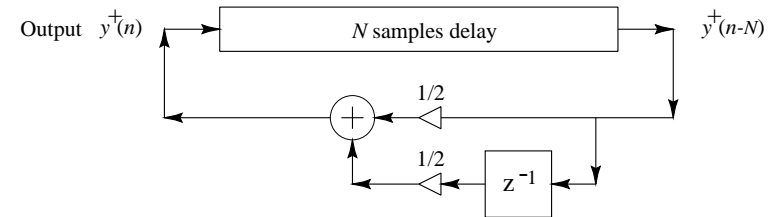

Physical Interpretation

- Delay line is initialized with *noise* (random numbers)
- Therefore, assuming a *displacement-wave* simulation:
 - Initial string *displacement* = *sum* of delay-line halves
 - Initial string *velocity* determined by the *difference* of delay-line halves
- The Karplus-Strong “string” is thus *plucked and struck* by random amounts along the *entire length of the string!* (the “splucked string”?)
- Karplus-Strong feedback filter corresponds to the *simplest possible damping filter* for an ideal string

Extended Karplus-Strong (EKS) Algorithm (Jaffe-Smith 1983)

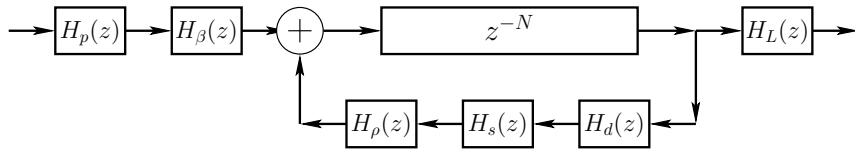

N = pitch period ($2 \times$ string length) in samples

$$H_p(z) = \frac{1-p}{1-pz^{-1}} = \text{pick-direction lowpass filter}$$

$$H_\beta(z) = 1 - z^{-\beta N} = \text{pick-position comb filter, } \beta \in (0, 1)$$

$$H_d(z) = \text{string-damping filter (one/two poles/zeros typical)}$$

$$H_s(z) = \text{string-stiffness allpass filter (several poles and zeros)}$$

$$H_\rho(z) = \frac{\rho(N) - z^{-1}}{1 - \rho(N)z^{-1}} = \text{first-order string-tuning allpass filter}$$

$$H_L(z) = \frac{1 - R_L}{1 - R_L z^{-1}} = \text{dynamic-level lowpass filter}$$

EKS Sound Example

Bach A-Minor Concerto—Orchestra Part: (WAV) (MP3)

- Executes in real time on one Motorola DSP56001 (20 MHz clock, 128K SRAM)
- Developed for the NeXT Computer introduction at Davies Symphony Hall, San Francisco, 1989
- Solo violin part was played live by Dan Kobialka of the San Francisco Symphony

Example EKS Extension

Many of the Karplus-Strong algorithm extensions were based on its *physical interpretation*.

- Originally, transfer-function methods were used.
- Below, we will use digital waveguide methods, which came a couple of years later.

String Excited Externally at One Point

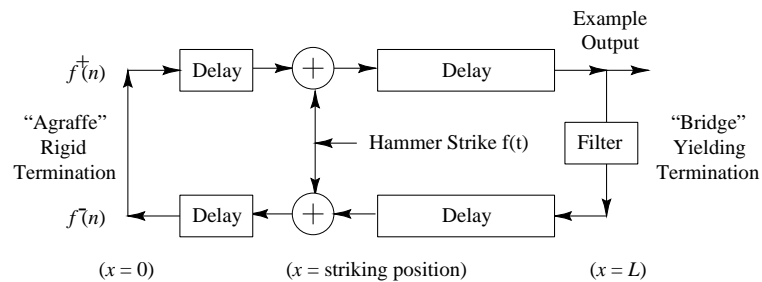

"Waveguide Canonical Form"

Equivalent System: Delay Consolidation

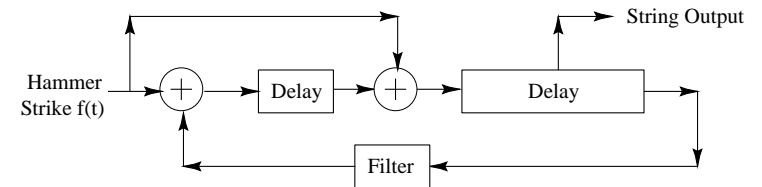

Finally, we "pull out" the comb-filter component:

EKS “Pick Position” Extension

Equivalent System: Delay-Lines Consolidated

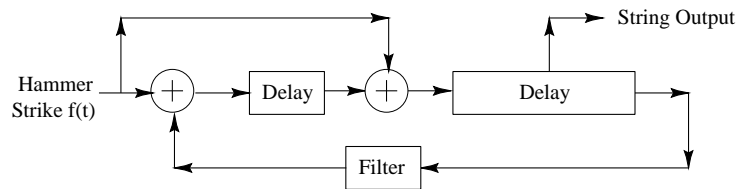

Equivalent System: Comb Filter Factored Out

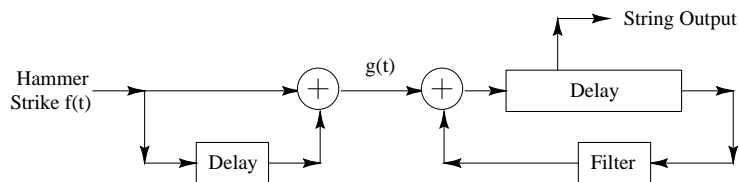

- *Excitation Position* controlled by left delay-line length
- *Fundamental Frequency* controlled by right delay-line length

PLPC Cello (1982)

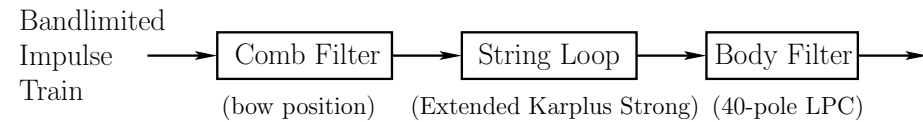

- Periodic LPC used to estimate string-loop filter
- Normal LPC used for body model (40 poles)
- Excitation = Bandlimited impulse train:

$$\sum_{k=1}^K \cos(k\omega_0 t) = \frac{\sin[(K + 1/2)\omega_0 t]}{2 \sin(\omega_0 t/2)} - \frac{1}{2}$$

- Bow-position simulation = variable-delay differencing comb filter (direct from physical interpretation)
- **Sound Example:**
Moving Bow-Stroke Example: (WAV) (MP3)
(Bowing point moves toward the “bridge”)

Single-Reed Instruments (1986)

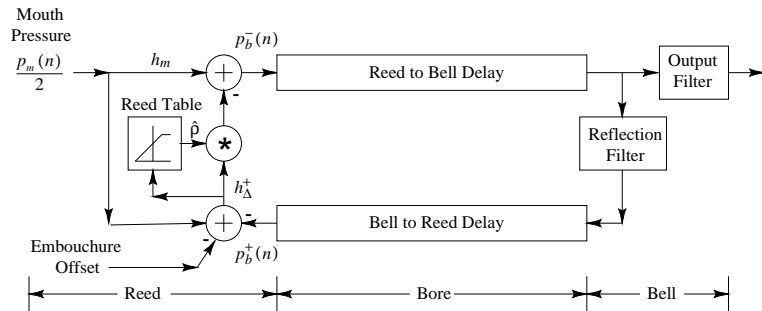

Sound Examples

- STK Clarinet: (WAV) (MP3)
- Staccato Systems Slide Flute (based on STK flute): (WAV) (MP3)
- Yamaha VL1 Shakuhachi: (WAV) (MP3)
- Yamaha VL1 Oboe and Bassoon: (WAV) (MP3)
- VL1 Tenor Saxophone: (WAV) (MP3)
- Google search: *STK clarinet*
- Synthesis Tool Kit (STK) by Perry Cook, Gary Scavone, and others, distributed by CCRMA:
<http://ccrma.stanford.edu/CCRMA/Software/STK/>

Bowed Strings (1986)

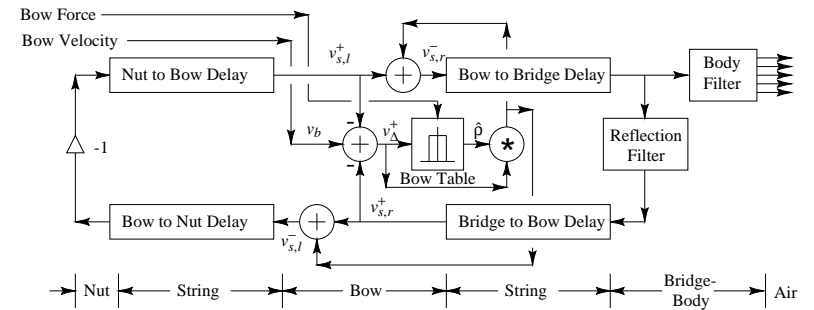

- Reflection filter summarizes all losses per period (due to bridge, bow, finger, etc.)
- Bow-string junction = *memoryless* lookup table (or segmented polynomial) \Rightarrow no thermodynamic model in this version
- Bow-hair dynamics neglected
- Finite bow width neglected

Bowed String Sound Examples

Cello sound examples by Stanford EE graduate student **Peder Larson** using the Synthesis Tool Kit (STK) by Perry Cook and Gary Scavone:

- STK Bowed class, no modifications: (WAV) (MP3)
- Hyperbolic Bow-String Junction, including: (WAV) (MP3)
 - Torsional waves: (WAV) (MP3)
 - Finite Bow Width: (WAV) (MP3)
 - Finite Bow Width and Torsional waves: (WAV) (MP3)
 - Finite Bow Width and Body Filter: (WAV) (MP3)
 - Torsional waves and Body Filter: (WAV) (MP3)
 - Finite Bow Width, Torsional waves, Body Filter: (WAV) (MP3)
 - String Dispersion (Stiffness): (WAV) (MP3)
 - Including Torsional waves and dispersion: (WAV) (MP3)
 - Finite Bow Width and Dispersion: (WAV) (MP3)
 - Finite Bow Width, Torsional Waves, Dispersion: (WAV) (MP3)

- Finite Bow Width, Body Filter, and Dispersion: (WAV) (MP3)
- Torsional waves, Body Filter, and Dispersion: (WAV) (MP3)
- Same plus Finite Bow Width: (WAV) (MP3)

Cello Examples Using All Features

- Staccato Notes: (WAV) (MP3)
- Bach's First Suite for Unaccompanied Cello: (WAV) (MP3)

Staccato notes created with short strokes of high bow pressure (like a bouncing bow)

Without Dispersion

- Staccato notes: (WAV) (MP3)
- Bach's First Suite for Unaccompanied Cello: (WAV) (MP3)

Nonlinear “Overdrive”

Soft Clipper

$$f(x) = \begin{cases} -\frac{2}{3}, & x \leq -1 \\ x - \frac{x^3}{3}, & -1 \leq x \leq 1 \\ \frac{2}{3}, & x \geq 1 \end{cases}$$

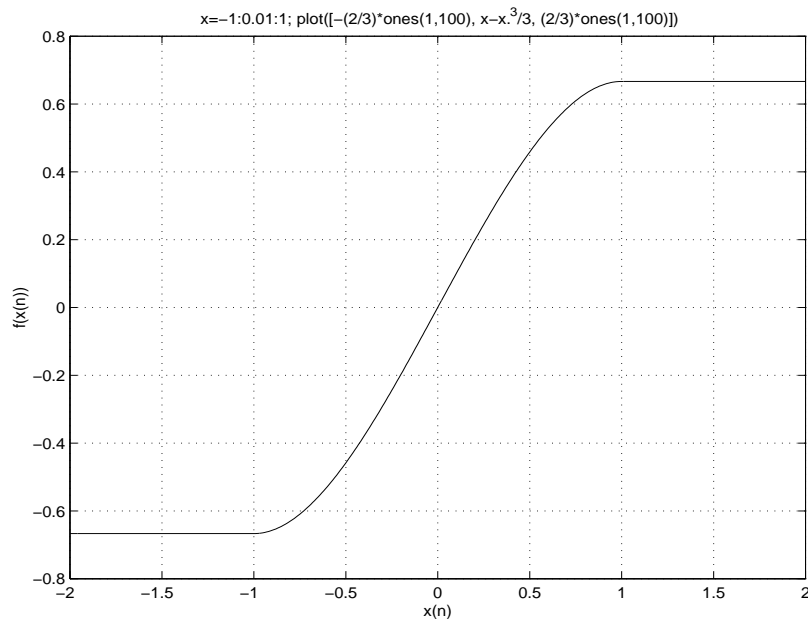

Amplifier Distortion + Amplifier Feedback

Sullivan 1990

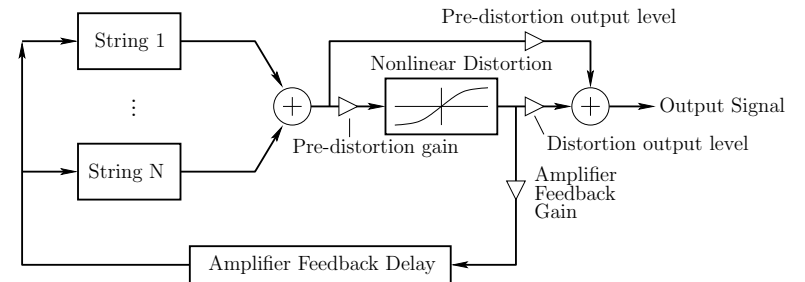

Distortion output signal often further filtered by an *amplifier cabinet filter*, representing speaker cabinet, driver responses, etc.

Sound Examples

- Distortion Guitar: (WAV) (MP3)
- Amplifier Feedback 1: (WAV) (MP3)
- Amplifier Feedback 2: (WAV) (MP3)

Commuted Synthesis of Acoustic Strings (1993)

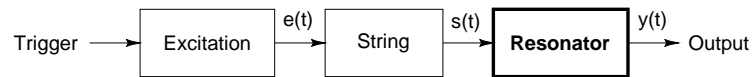

Schematic diagram of a stringed musical instrument.

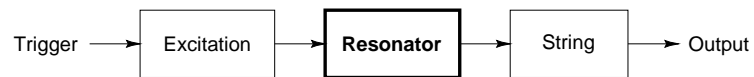

Equivalent diagram in the linear, time-invariant case.

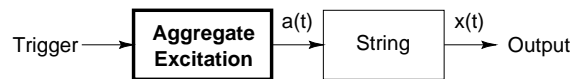

Use of an aggregate excitation given by the convolution of original excitation with the resonator impulse response.



Possible components of a guitar resonator.

Commuted Synthesis Sound Examples

Acoustic Guitar

- Bach Prelude in E Major: (AIFF) (MP3)
- Bach Loure in E Major: (AIFF) (MP3)

Virtual performance by Dr. Mikael Laurson¹, Sibelius Institute
Virtual guitar by Helsinki University of Technology, Acoustics Lab²

Electric Guitar (Pick-Ups and/or Body-Model Added)

- Example 1: (WAV) (MP3)
- Example 2: (WAV) (MP3)
- Example 3: (WAV) (MP3)
- Virtual “wah-wah pedal”: (WAV) (MP3)

Stanford Sondius Project
Staccato Systems, Inc.

STK Mandolin

- STK Mandolin 1: (WAV) (MP3)
- STK Mandolin 2: (WAV) (MP3)

¹<http://www2.siba.fi/soundingscore/MikaelsHomePage/MikaelsHomepage.html>

²<http://www.acoustics.hut.fi/>

Commutated Synthesis of Linearized Violin

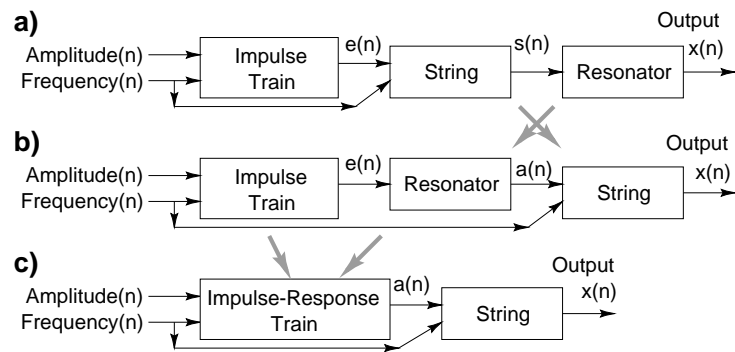

- Assumes *ideal Helmholtz motion* of string
- Sound Examples:
 - Double Bass: (WAV) (MP3)
 - Cello: (WAV) (MP3)
 - Viola 1: (WAV) (MP3)
 - Viola 2: (WAV) (MP3)
 - Violin 1: (WAV) (MP3)
 - Violin 2: (WAV) (MP3)
 - Ensemble: (WAV) (MP3)

Stanford Sondius Project
Staccato Systems, Inc.

Commutated Piano Synthesis (1995)

Hammer-string interaction pulses (force):

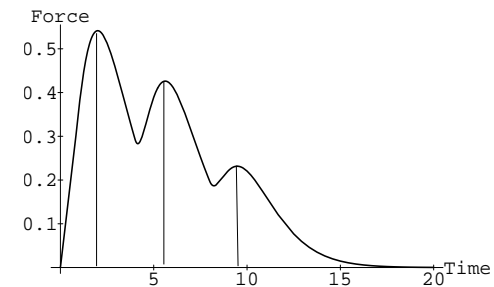

Vertical lines specify three *impulses* which will drive one to three *pulse-synthesis filters*

- Hammer = *mass covered by nonlinear spring* (“felt”)
- String looks like a *resistor* upon initial impact
- Second and third pulses caused by *reflections* from agraffe (number depends on key number and hammer velocity)
- Pulses taller and thinner when hammer-velocity larger

Synthesis of Hammer-String Interaction Pulse

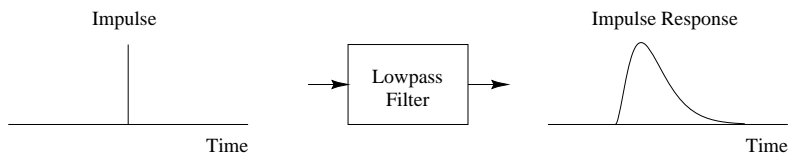

- Faster collisions correspond to *narrower* pulses (*nonlinear filter*)
- For a *given velocity*, filter is linear time-invariant
- Piano is “linearized” for each hammer velocity

Multiple Hammer-String Interaction Pulses

Superimpose several individual pulses:

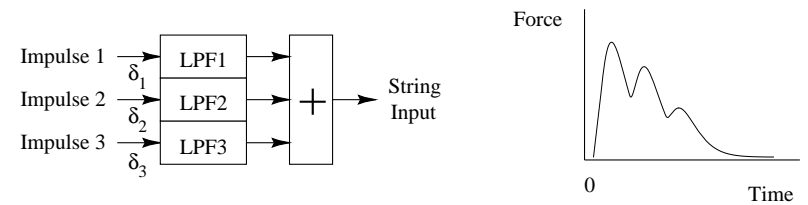

As impulse amplitude grows (faster hammer strike), output pulses become *taller and thinner*, showing less overlap.

Complete Piano Model

Natural Ordering:

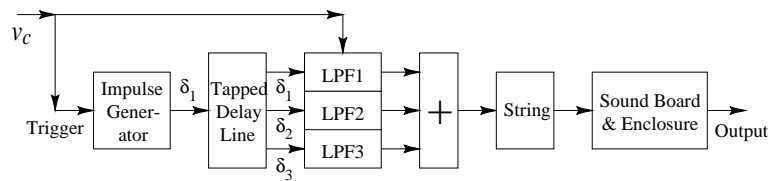

Commuted Ordering:

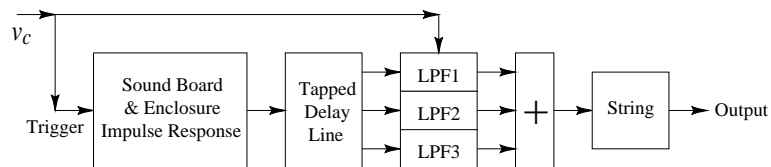

- Soundboard and enclosure are *commuted*
- Only need a stored recording of their *impulse response*
- An enormous digital filter is otherwise required

Sound Examples

Piano and Harpsichord:

- Piano: (WAV) (MP3)
- Harpsichord 1: (WAV) (MP3)
- Harpsichord 2: (WAV) (MP3)

Stanford Sondius Project
Staccato Systems, Inc.

More Recent Harpsichord:

- Harpsichord Soundboard Hammer-Response: (WAV) (MP3)
- Musical Commuted Harpsichord Example: (WAV) (MP3)

Vesa Välimäki, Henri Penttinen, Jonte Knif, Mikael Laurson, and
Cumhur Erkut

“Sound Synthesis of the Harpsichord Using a Computationally
Efficient Physical Model”, JASP-2004

<http://www.acoustics.hut.fi/publications/papers/jasp-harpsy/>
Google search: *Harpsichord Sound Synthesis*

Virtual Analog Synthesis

Most “Virtual Analog” synthesizers try to emulate some version of the MiniMoog or MemoryMoog synthesizers, because of their popularity. These classic synths were designed by the analog-synth pioneer Robert Moog.



Early Examples of Virtual Analog Synths:

- Nordlead “Virtual Analog Synthesizer”
- Roland “Analog Modeling Synthesis”
- Yamaha “Analog Physical Modeling” (AN-1)

Design goal: Emulate the Moog Voltage Controlled Filter (VCF), due its popularity and excellent properties.

Moog VCF Ladder (1966)

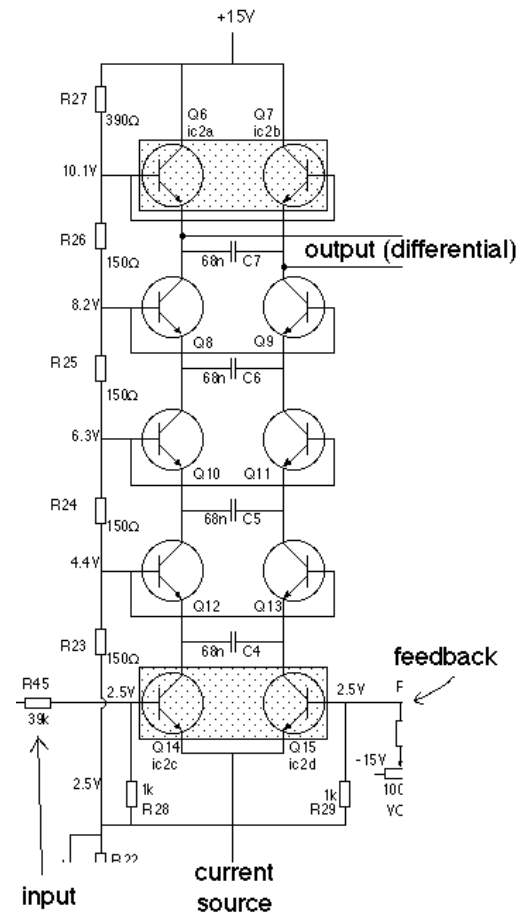

moog
Voltage Controlled Ladder Filter

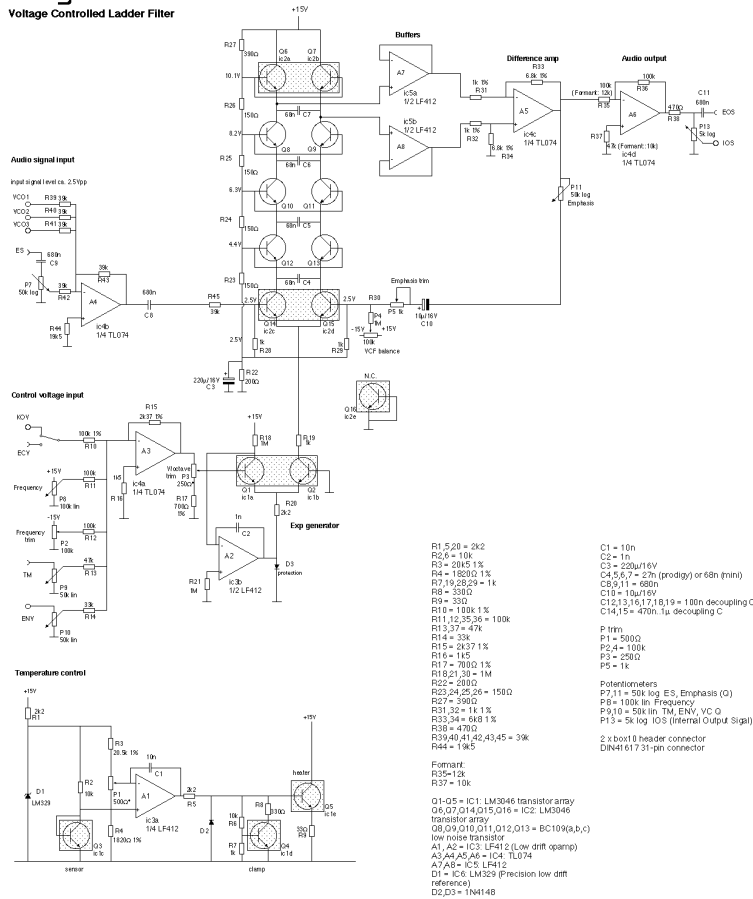

- All resistors recommended metal film
- Cermet trimmers recommended (especially P2 and P3)
- Capacitors MKM or MKF recommended

- The exp generator is inspired by the Elektor Formant VCO's exp generator
- Temperature control as in National Semiconductor Application Note AN-299 with added temperature adjustment.
- Pin-compatible with the Formant regular VCF

Revision 1.2
Last change: June 10th 1996

Many thanks to Don Tillman and Barry Klein for invaluable discussions.

© 1994, 1995 by Rick Jansen (rick@sara.nl)

The Moog VCF (1966)

Structure: four identical one-poles in series with a feedback loop:

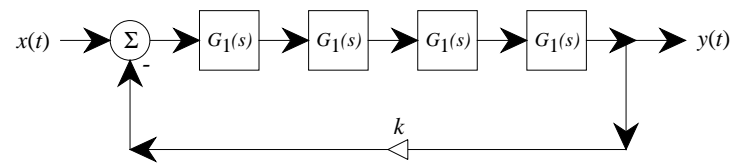

This implements a voltage-controllable four-pole filter:

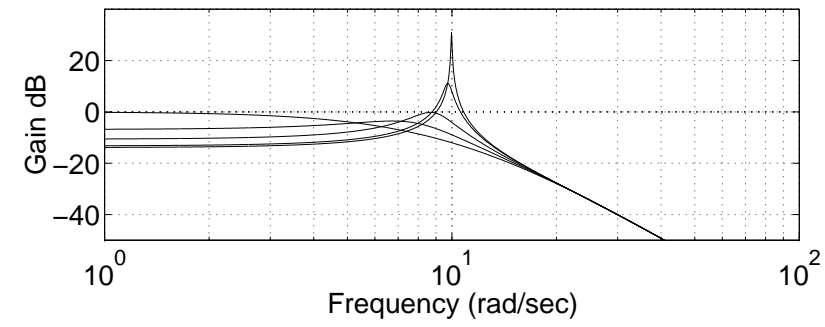

In the Moog analog ladder (the "Moog 904A"), the one-pole filters consist of the capacitors and the AC resistance of the transistors, which is determined by the current source, which is varied to control tuning. See US Patent 3,475,623

Moog VCF Controls

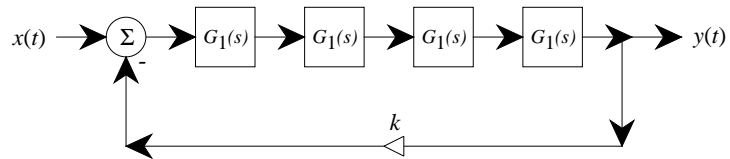

Controls

- One-pole pole location: controls *cut-off frequency*
- Feedback gain: controls *resonance*

Resonance

- The phase of each pole at $s = -a$ is 45° when $s = ja$
- At this frequency ($\omega = a$), the phase through all four filters is 180°
- The gain of each one-pole at $\omega = a$ is $1/\sqrt{2}$
 \Rightarrow total gain is $1/4$
- Therefore, with a feedback gain of $k = 4$, the loop has *in-phase, positive feedback* at frequency $\omega = a$

Moog VCF Root Locus

Some root loci of the continuous-time Moog VCF:

Root locus as k varies:

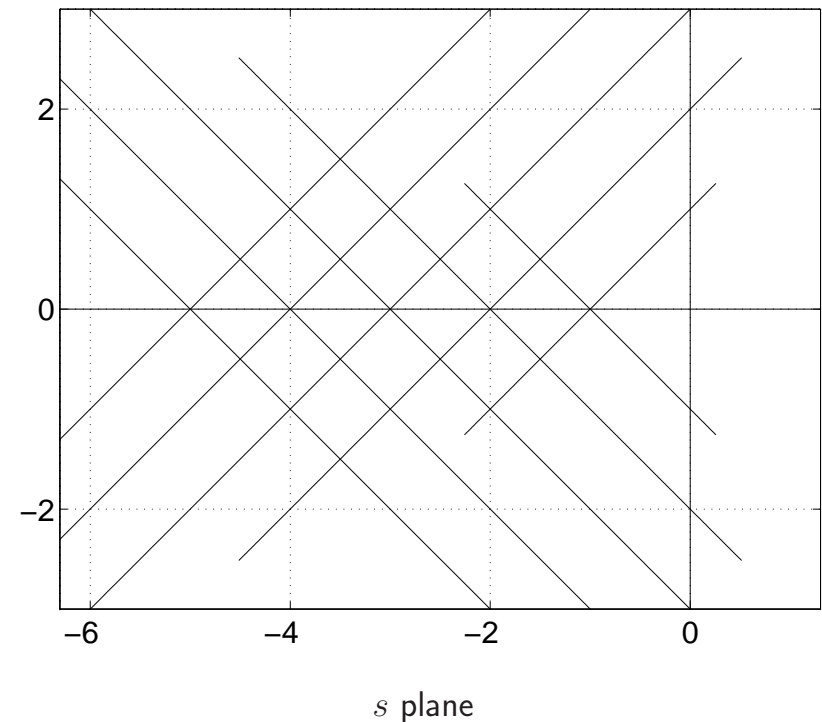

Root locus as one-pole location (p) varies:

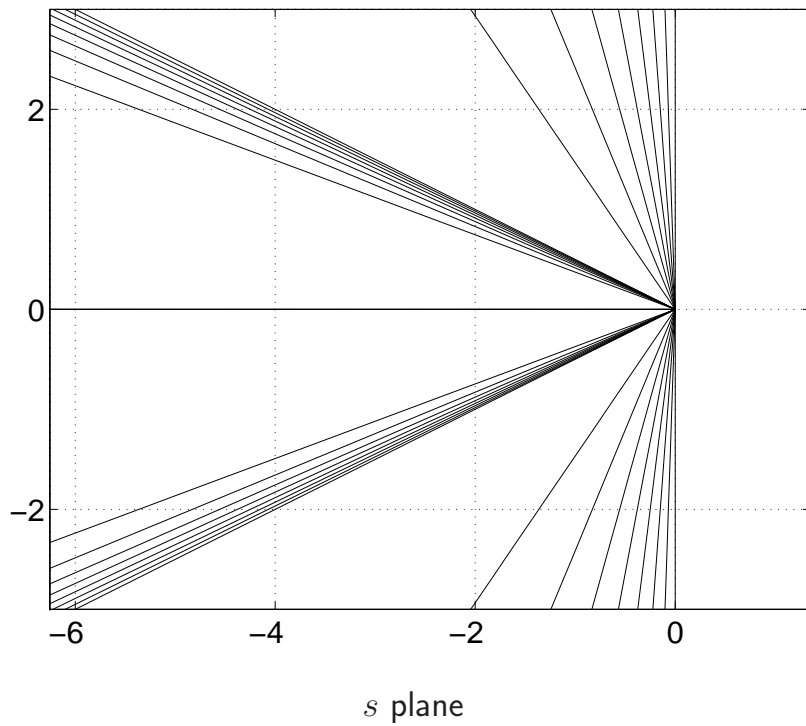

Features of the Moog VCF

These loci show why the Moog VCF is such a good structure:

- Controls for cut-off and Q are completely orthogonal (constant- k contours are constant- Q contours)
- Controls are simply related to circuit parameters (resonance frequency = open-loop poles)

Discrete-Time Moog VCF (1996)

Stilson and Smith, ICMC-96

Within the original structure (four one-poles in series with feedback around them), try various transforms from s to z :

Backward difference: $G(z) = (p + 1)z / (z + p)$

Bilinear: $G(z) = 0.5(p + 1)(z + 1) / (z + p)$

- **Problem:** Delay-free loops: These transforms cause the one-poles to have delay-free paths. Adding a delay to the loop changes the structure, so that complete orthogonality is no longer true (before the added delay, the bilinear case *was* orthogonal).
- *Separation tables* become necessary: The table we will use, in the bilinear-transform case, is a one-dimensional table that contains the feedback gain necessary to make the filter unstable, indexed by p . We scale k by this table ($k = \text{table}(p)k_{in}$).
- We would like to find a structure for which a separation table is unnecessary.

Separation Table

For the bilinear case, the separation table is the top curve:

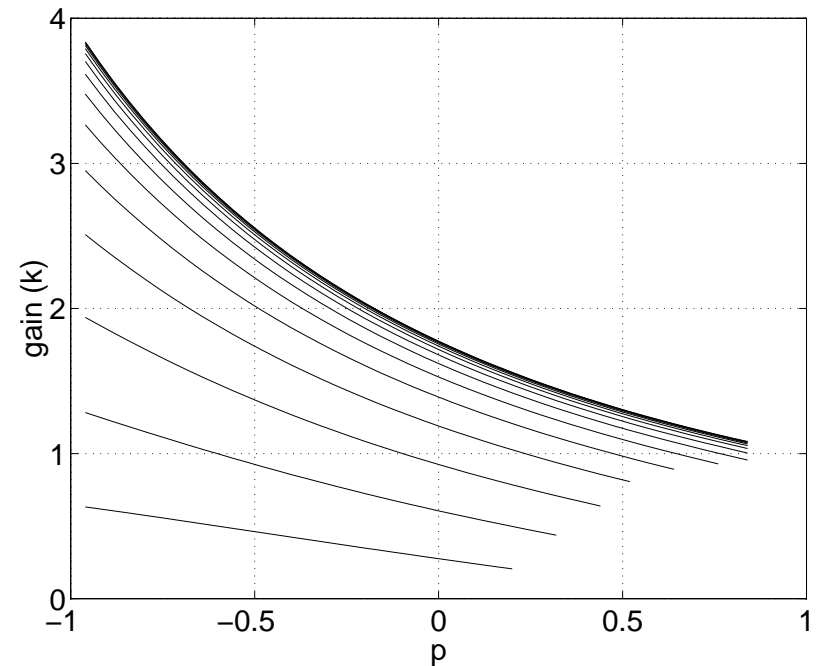

The other curves show gains for various values of Q (the top is infinite- Q).

Root Locus, Bilinear Transform Case (Using Separation Table)

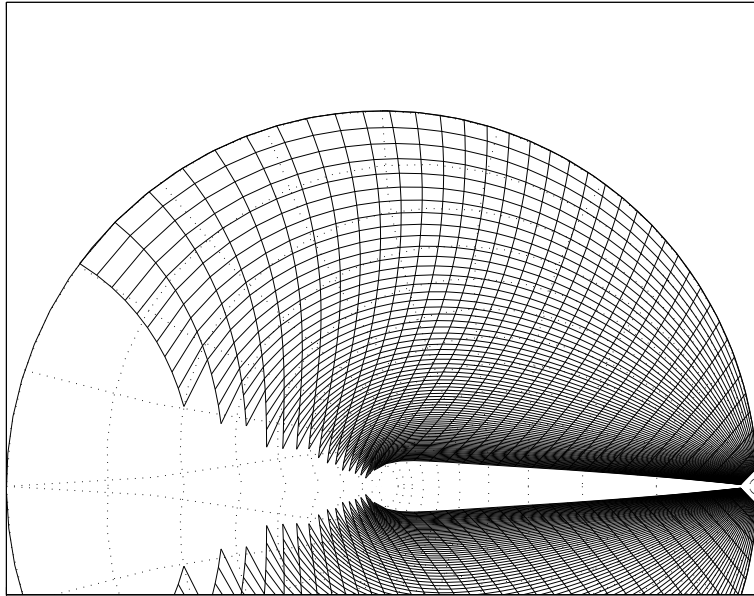

Each curve generated by sweeping p with a fixed k

Q versus Cut-Off Frequency, Bilinear Transform, With Separation Table

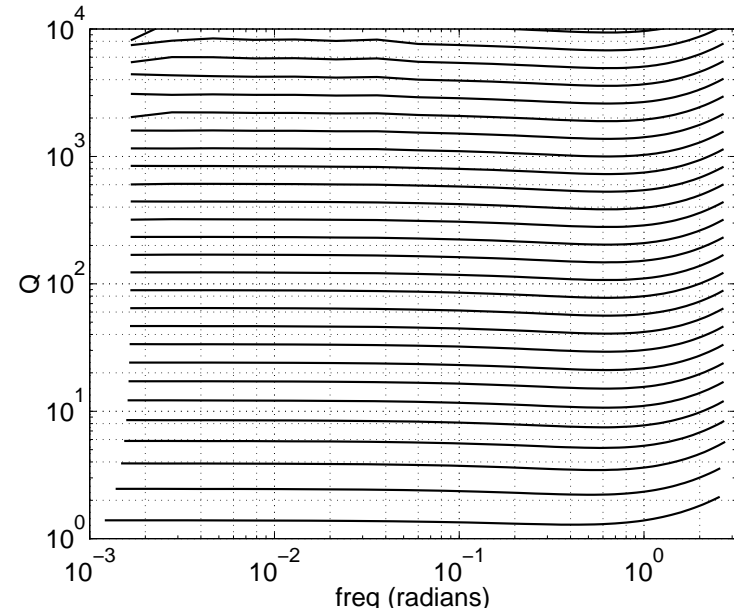

This case used the separation table for stability reasons.

Bode plots (medium Q)

Bilinear transform with separation table:

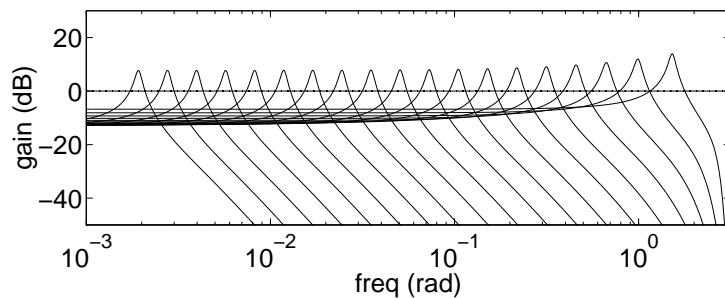

Backwards difference, no separation table:

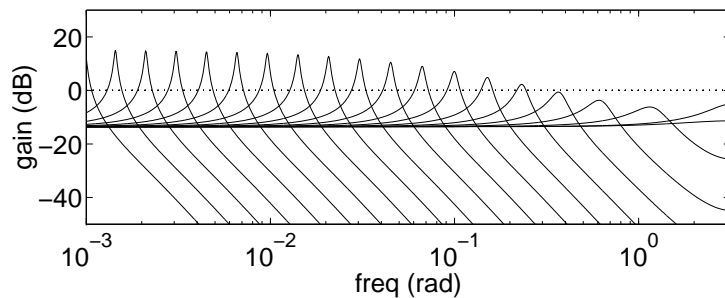

Notes

- Constant-Q is hard for digital filters
 - Constant-Q tracks are logarithmic spirals
 - These aren't "root-locus primitives"
 - The separation table does a good job making constant-Q (didn't necessarily expect this)
- Look at zero locations between the two cases (remembering that we would like to get rid of the table). First, review the parameters we have to control:
 - easiest: the zero locations
 - also easy: the relative open-loop pole locations (so far, have only really looked at all equal)
 - more expensive: frequency-to-pole and Q-to-feedback-gain mapping functions (or more esoteric mappings)

Note that

- backwards-difference yields zeros at $z = 0$
- bilinear transform yields zeros at $z = -1$

Try other locations...

Discovery: There is a very good choice

Zeros at $z = 0.3$
(Tim Stilson 1996)

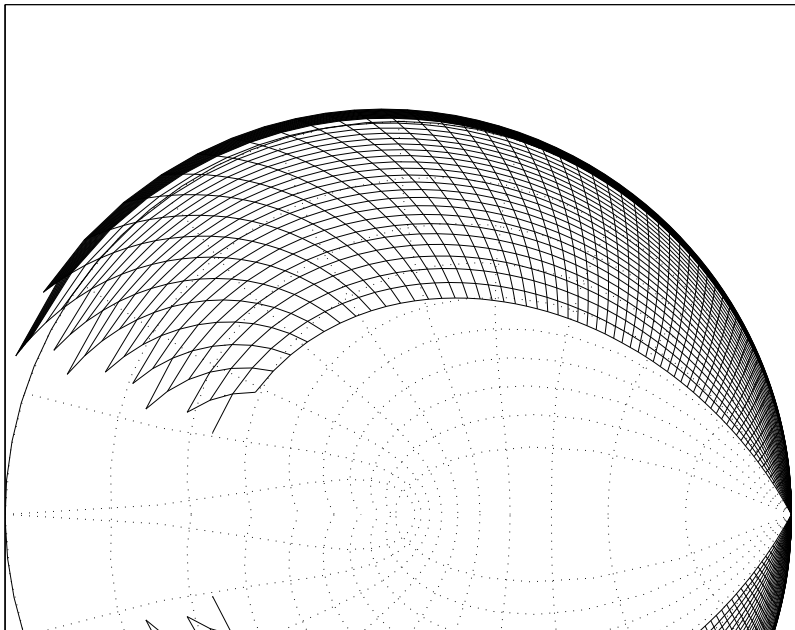

Root Locus vs. Tuning

Zeros at $z = 0.3$ — Q vs. Tuning

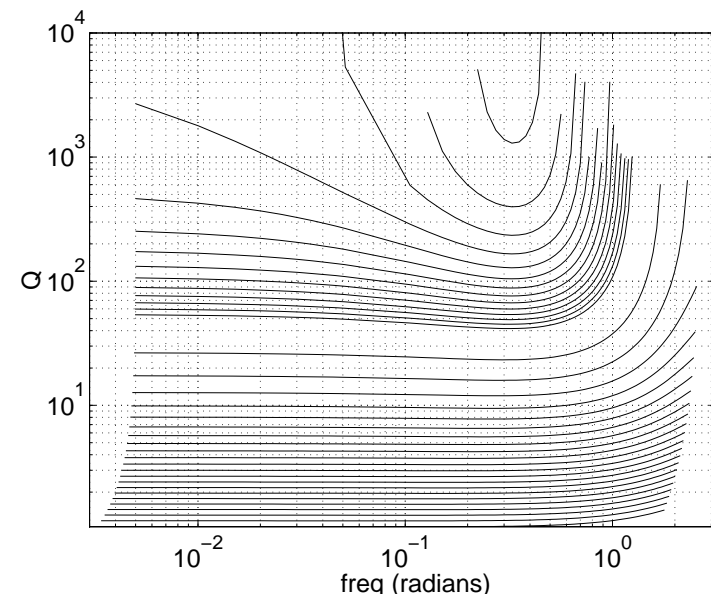

- Note that the Q-vs-frequency curves are pretty flat for $Q < 100$ for cut-off freq.s over most of the range
- This is quite good for not using a separation table

Zeros at $z = 0.3$ — Bode Plot

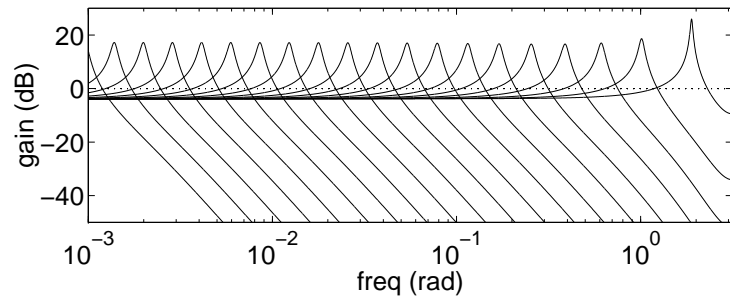

Farewell Bob Moog—and Thank You!



Robert A. Moog (1934–2005)

Online Resources

- This presentation:
<http://ccrma.stanford.edu/~jos/Mohonk05/>
- Book chapter from which the proceedings paper was condensed:
http://ccrma.stanford.edu/~jos/pasp/-History_Enabling_Ideas.html